

kindred[®]
FITTED BEDROOM FURNITURE



**THE ITALIAN
KITCHEN COMPANY**

MAKE ROOM





MAKE ROOM

FOR KINDRED

Designed to inspire. Made for real life.

Here at Kindred, we don't believe that limited space or awkward footprints should compromise your bedroom's style. From classic to modern, we have an abundance of design possibilities ready and waiting, to customise and create your dream room.

Whether it's a sanctuary for contemplation, an inviting room to welcome guests, or simply somewhere to escape from the chaos of life, our experts have crafted a beautiful collection of bedroom furniture, ensuring we have a style to perfectly suit any space.

Seamlessly balancing design and functionality, our extensive range of premium quality fitted furniture, offers a unique versatility that can be tailored exclusively around you and your lifestyle.

Packed full of the very latest ideas in bedroom furniture, this inspiration book aims to provide you with the confidence to turn your dreams into reality, whilst our network of specialist retailers across the UK, are on hand to take care of you every step of the way.

italiankitchenco.com/kindred

kindred[®]



THE ITALIAN
KITCHEN COMPANY



alet

TRADE US
NO LATER
NO BATES
A Big Boy
REMINGTON

**MADE
BEAUTIFULLY
WITH YOU
IN MIND**



THE ITALIAN

KITCHEN COMPANY

SPACE



We'll help you achieve more than you ever thought possible

Our range of beautifully crafted collections will fit flawlessly into any space, and offer twice as much storage as a free-standing unit.

QUALITY



The pride of workmanship

Mixing Italian flair with Great British design, our experts have perfectly crafted an extensive collection of fitted furniture, that will form a timeless setting for years to come.

STORAGE



The perfect wardrobe starts from within

Our array of internal storage solutions offer clever, flexible and innovative design, ensuring we make the most of every footprint to maximise your space.

DESIGN



Make it simple, but significant

Bringing you an abundance of design possibilities, we scour the world to find the very latest styles, colours and finishes, ready to transform your space.

THE KINDRED JOURNEY



BE INSPIRED

From contemporary to classic, our expert designers have crafted an extensive collection of bedroom looks, to suit an array of budgets, spaces and styles.

Feeling inspired? Find your dream bedroom in our brochure or visit us online: www.kindred.co.uk



KNOW YOUR SPACE

When planning your dream room, it really helps to identify your needs. *Who, what, when, where, why, how?* Who is the room for, why do you need it, what exactly do you need, when do you need it by and where would you like it to go?

Once, you've established all of this, we'll help you conquer the rest; we can make the 'how' possible!



VISIT YOUR NEAREST KINDRED SPECIALIST

We're proud to rely on a select network of furniture specialists across the country, so your dream room is never far away. Our expert team will be on hand with advice and knowledge, whilst you explore the showroom and gather ideas.

To find your nearest Kindred retailer, visit: www.kindred.co.uk/findaretailer



MEASURED AND CHECKED FOR YOU

We understand that the finer details can make or break the end result. That's why it's important to be guided through the entire process. From checking the space is suitable for the intended design, to pre-installation advice or even any special requirements; when you make room for Kindred, we make room for you.



MAKE YOURSELF AT HOME

Finally, your perfect place for contemplation is complete, but just before you sit back and relax, take the time to organise your belongings, to truly make the most of your brand new fitted furniture.

THE CLASSIC COLLECTION

Guided by a passion for history, lovers of the classic style have an eye for timeless design that harks back to a bygone era.

The Classic Collection is inspired by the exquisiteness and craft of the past, and re-imagined for the 21st century. The natural partner for Victorian and Edwardian period homes, it also sits perfectly in modern properties, adding a sophisticated elegance.

From the simple beauty of Origin through to the refined decadence of Chapter, this collection's neutral colour palette allows you to create your own vision of traditional beauty.



**THE
MODERN
COLLECTION**

THE MODERN COLLECTION

True modernists live life at pace. As embracers of change, they look to tomorrow in pursuit of the next innovation. Those who love modern seek designs where simplicity and functionality are effortlessly entwined.

The modern collection shows an array of creative options and room designs, integrating modern functions seamlessly with the architecture of the bedroom.

Make room for Parity, Flow, Sculpt and Esker. Available in four colours and two finishes.





The Modern Collection

PARITY

A true reflection of balance.

With its minimalist form and linear appearance, Parity's purist nature can adapt to any space.

The simplicity of Parity allows you to create everything from the most minimal of looks, to the most glamorous of boudoirs. A blank canvas for your individual style.



Single

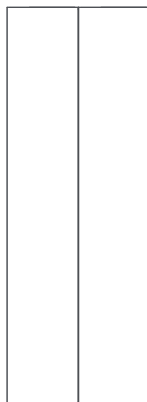

Double



Feature Mirror
(Grey tinted mirror)



Feature Glass
(Bronze tinted glass)

THE MODERN COLLECTION

Available in four colours; four matt and three gloss.



CASHMERE
MATT/GLOSS



DOVE GREY
MATT/GLOSS



WHITE
MATT/GLOSS

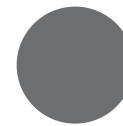

ANTHRACITE
MATT ONLY



PARITY

Shown in Cashmere

1. Three walnut internal stackable drawers and pigeon hole unit
2. Handle from the Chrome Collection (KDH3008)
3. Gloss Cashmere four drawer modern chest
4. Gloss Cashmere three drawer modern bedside chest
5. Parity wardrobe with feature mirror doors



GET THE LOOK

The warm tonal palette of Cashmere, Walnut and dusky pink brings a sumptuous feeling to the most modest of master bedrooms.

With plush soft furnishings, reflections from gloss finishes and dazzling handles, this style radiates pure elegance.





3

PARITY
SHOWN IN GLOSS CASHMERE



4



5



PARITY

Shown in Matt White

1. Stable wardrobe with four drawer modern chest
2. Modern 4 drawer chest open drawer detail
3. Additional linen shelves
4. Stable wardrobe with four drawer modern chest



GET THE LOOK

The crisp white tones and linear form provide a canvas for this simple, effortless and uncomplicated style.

This room maximises storage on the smaller footprint, without compromising on design.





2



PARITY
SHOWN IN MATT WHITE



3



4





GET THE LOOK

A perfect example of functional storage paired with a simple relaxed design. The calming colour palette adds to the serenity of the interior and creates a tranquil atmosphere.



PARITY

Shown in Gloss Dove Grey

1. Handle from the Timber Collection (KDH3033)
2. Additional Linen shelves
3. Handle from the Timber Collection (KDH3033)
4. Bespoke angled unit made with Oak shelves



PARITY
SHOWN IN GLOSS DOVE GREY



The Modern Collection

FLOW

Stripped back and seamless, Flow has been designed with purity in mind.

Uncomplicated yet striking, the integrated handle creates a simple form through a fluid streamlined design. From the functional to the fashionable, Flow offers versatility that works across multiple styles.



Single

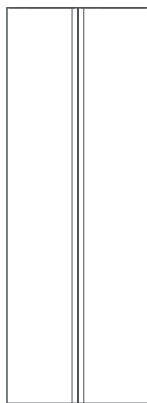

Double



Feature Mirror
(Grey tinted mirror)

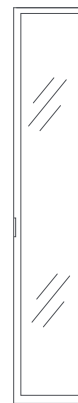

Feature Glass
(Bronze tinted glass)

THE MODERN COLLECTION

Available in four colours; four matt and three gloss.



CASHMERE
MATT/GLOSS



DOVE GREY
MATT/GLOSS



WHITE
MATT/GLOSS



ANTHRACITE
MATT ONLY





FLOW

Shown in Gloss White

1. Feature storage unit
2. Two Linen internal stackable drawers and pigeon hole unit
3. Four drawer modern chest
4. Gloss white three drawer modern bedside
5. Handle from the Chrome Collection (KDH3014)





**THE ITALIAN
KITCHEN COMPANY**

GET THE LOOK

A delicate touch of glamour is created with the gloss white, plush velvets, silver hues and crystal details.

Create a multi-purpose wardrobe design by cleverly building around a dis-used chimney breast, giving a more contemporary look to a period property.



FLOW
SHOWN IN GLOSS WHITE



GET THE LOOK

Simple but effective, a low media unit demonstrates a fresh approach to storage for a more contemporary design.

The blue feature wall, coupled with lighter dove grey tones, creates the ideal backdrop to express a bold style.



FLOW

Shown in Matt Dove Grey

1. Standard wardrobe internal
2. Open Flow wardrobes with feature storage units as a media unit
3. Handle from the Chrome Collection (KDH3030)
4. Modern bedside chest open drawer detail



FLOW
SHOWN IN MATT DOVE GREY





The Modern Collection

SCULPT

Inspired by Italian design,
Sculpt is bold and distinctive.

The integrated handle creates a strong structural statement. With its sculpted form and matt-painted finish, this range is a powerful statement that works across multiple interior styles.



Single

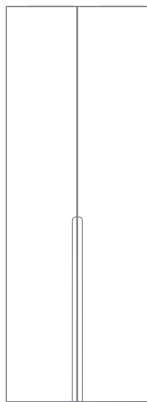

Double

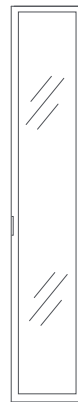

Feature Mirror
(Grey tinted mirror)

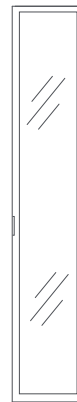

Feature Glass
(Bronze tinted glass)

Available in four matt colours.



CASHMERE
MATT ONLY



DOVE GREY
MATT ONLY



WHITE
MATT ONLY



ANTHRACITE
MATT ONLY



SCULPT

Shown in Matt Anthracite

1. Sculpt wardrobes with Feature Bronze glass
2. Sculpt integrated handle detail
3. Custom desk section created with Walnut internal stackable drawer, feature post and Anthracite accessories
4. Modern bedside chest with open drawer detail
5. Open Walnut internal stackable drawer



GET THE LOOK

An urban contemporary look is created with reclaimed timber flooring, country tweed upholstery and shades of grey.

The wall-to-wall wardrobes combined with a versatile workstation creates a multi-functional space.



1

2



SCULPT
SHOWN IN MATT ANTHRACITE



The Modern Collection

ESKER

Combining classic design principles
with contemporary vision.

Esker is carefully crafted and exquisitely shaped to give it a distinctive character. The matt-painted finish, coupled with subtle contours, adds to the sophistication of this range and creates a soft variation within the modern collection.



Single

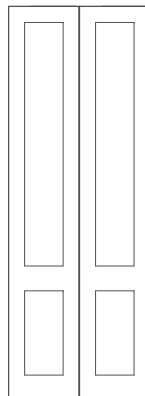

Double



Mirror

Available in three matt colours.



CASHMERE
MATT ONLY



DOVE GREY
MATT ONLY



ANTHRACITE
MATT ONLY



ESKER

Shown in Matt Anthracite

1. Anthracite three drawer modern bedside
2. Esker wardrobes with feature storage units
3. Additional Satin Brown hanging rail
4. Handle from the Black Collection (KDH3015 without backplate)





THE ITALIAN
KITCHEN COMPANY

GET THE LOOK

Embracing the architectural features by utilising the alcoves from floor to ceiling, with the addition of feature storage units. This design maximises space and uses the full height of the room.

The feature wall panelling, draws the eye in, to the striking tones of the Anthracite and Mustard. Creating a look of sophistication that is slightly edgy in character.





3

ESKER
SHOWN IN MATT ANTHRACITE



4





2

ESKER

Shown in Matt Cashmere

1. Open section showing walnut stackable drawers and pigeon hole unit
2. Matt cashmere four drawer modern bedside
3. Esker cashmere mirrored wardrobes
4. Handles from the Stainless Steel Collection (KDH3002)



3



THE ITALIAN
KITCHEN COMPANY

GET THE LOOK

Combining relaxed bohemian chic with soft cashmere shades, matt finishes and rich walnut woodgrains. The timeless earthy tones, soft linen, hessian textures and crochet detail, creates a relaxed atmosphere.

Accentuating the wall-to-wall wardrobes, a functional display unit creates a focal feature, making the most of a modest-sized master bedroom.



4





THE ITALIAN
KITCHEN COMPANY

WALK-IN WARDROBE

Adapting to any space, our open wardrobe solution in textured Linen creates the ultimate walk-in wardrobe; bringing achievable luxury to life.

Our open wardrobes paired with accessories from our existing ranges, provide a canvas for your individual style. Tailor your own bespoke design with our internal options in Linen, Walnut and Oak.

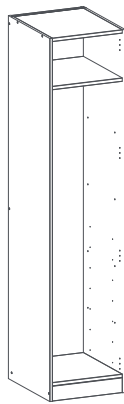

Single

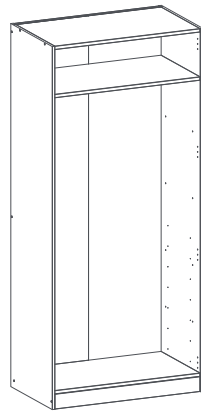

Double

Wardrobe widths
400, 450, 500, 800, 900, 1000



Wardrobes are always
in Linen

AVAILABLE COLOURS

For external dressing of the open wardrobes



TEXTURED
PORCELAIN



TEXTURED
PARTRIDGE GREY



TEXTURED
STONE



TEXTURED
OAK



WALNUT



ANTHRACITE
MATT ONLY



CASHMERE
MATT/GLOSS



DOVE GREY
MATT/GLOSS



WHITE
MATT/GLOSS

WALK-IN WARDROBE

* See internal storage section on page 119 for details on the internal options and colours.



GET THE LOOK

By building the wardrobes into all available space, and combining with a bespoke vanity area, this solution offers endless storage possibilities.

The fusion of White, Walnut and Linen, coupled with an array of internal options, creates a luxurious backdrop and satisfies a multitude of storage requirements.

The perfect walk-in wardrobe.



WALK-IN WARDROBE

Shown in Parity Matt White accessories and Walnut internals

1. Additional shelves in Walnut finish
2. A selection of internals in Walnut finish
3. Wardrobes showing feature mirror doors
4. Custom dressing table created with Walnut internal stackable drawer and Parity Matt White accessories



2



3

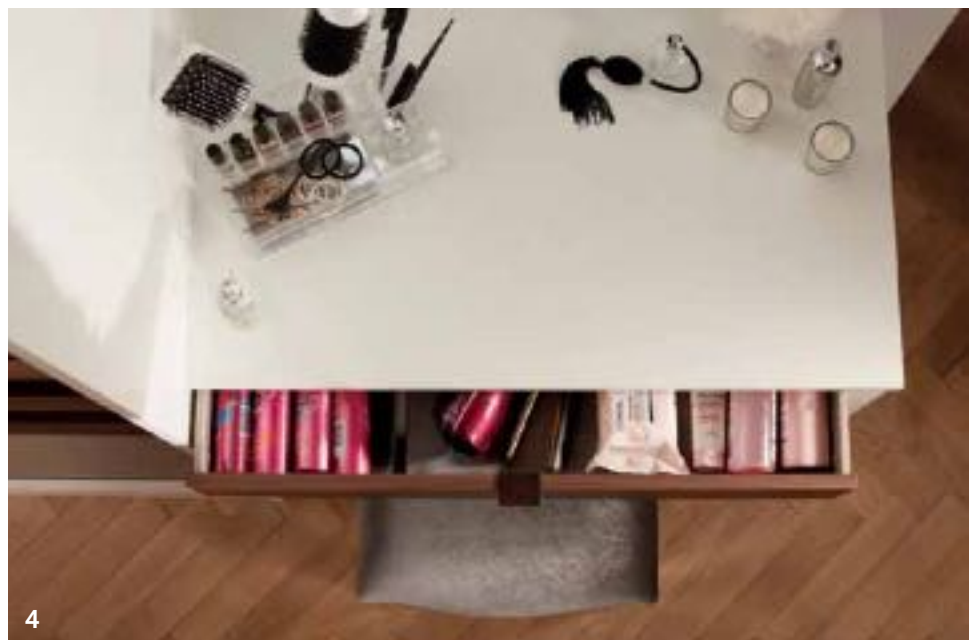

4

WALK-IN WARDROBE
SHOWN WITH PARIITY MATT WHITE ACCESSORIES AND WALNUT INTERNALS

PLANNING YOUR BEDROOM

HINGE COLLECTION

STEP 1

Measure your space

Ensure you are fully equipped to start planning. Measure your space wall to wall, including ceiling heights. Remember to note down things like:

- ✓ Sockets
- ✓ Switches
- ✓ Window ledges
- ✓ Doors
- ✓ Radiators

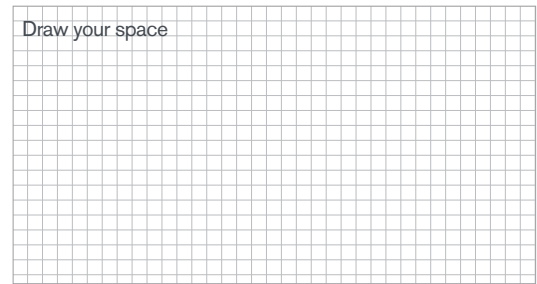

STEP 2

Create a wardrobe run

Get an idea of the wardrobe you want by adding combinations together.

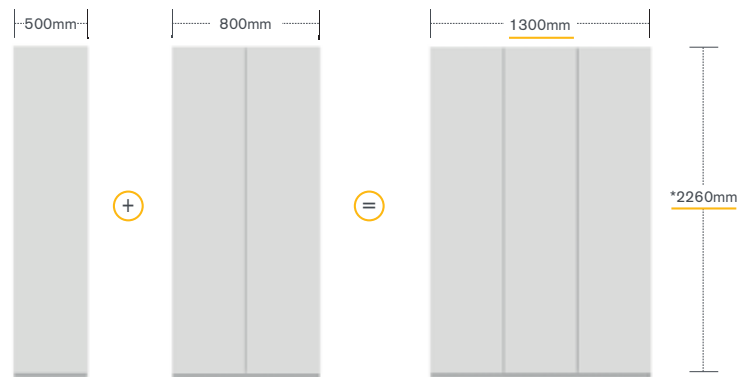

STEP 3

Add end panels/fillers or posts.

Depending on whether your design is wall to wall or open ended, you will need to add either an end panel or a custom fit plinth as a filler to cover the linen coloured cabinet.

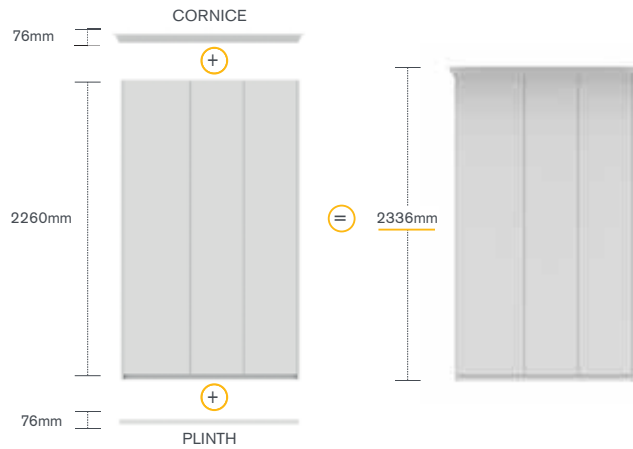
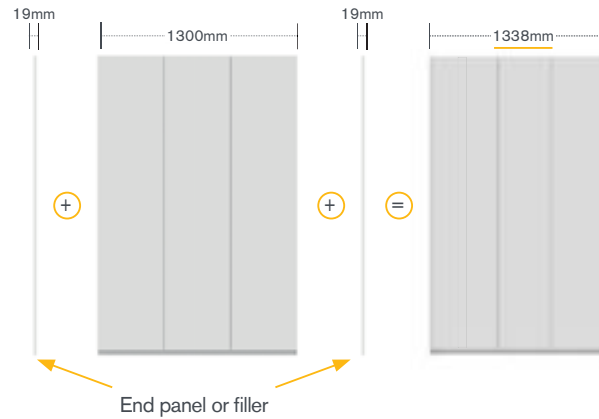

STEP 4

Add cornice and plinth

You will always need to use a length of plinth to cover the structural base of the wardrobe and depending on whether your design has the space, you can either add a cornice or an infill to ceiling, to finish off the wardrobe.

STEP 5

Add your internals

We have multiple internal storage options for our wardrobes. You can choose from pre-determined bundles or create and design your own, depending on your storage needs.

For the full internals section please see page 119.



THE MADE-TO-MEASURE COLLECTION





Creativity allows us to stretch our minds, do new and exciting things, and transcend traditional ideas to create new and meaningful ones.

The Made to Measure collection has been designed to allow creativity within storage; tailoring it to the exact contours of your space. Whether your rooms are small and compact, ultra-modern and minimal or grand and full of character, the Made to Measure collection allows for complete versatility within design and function.

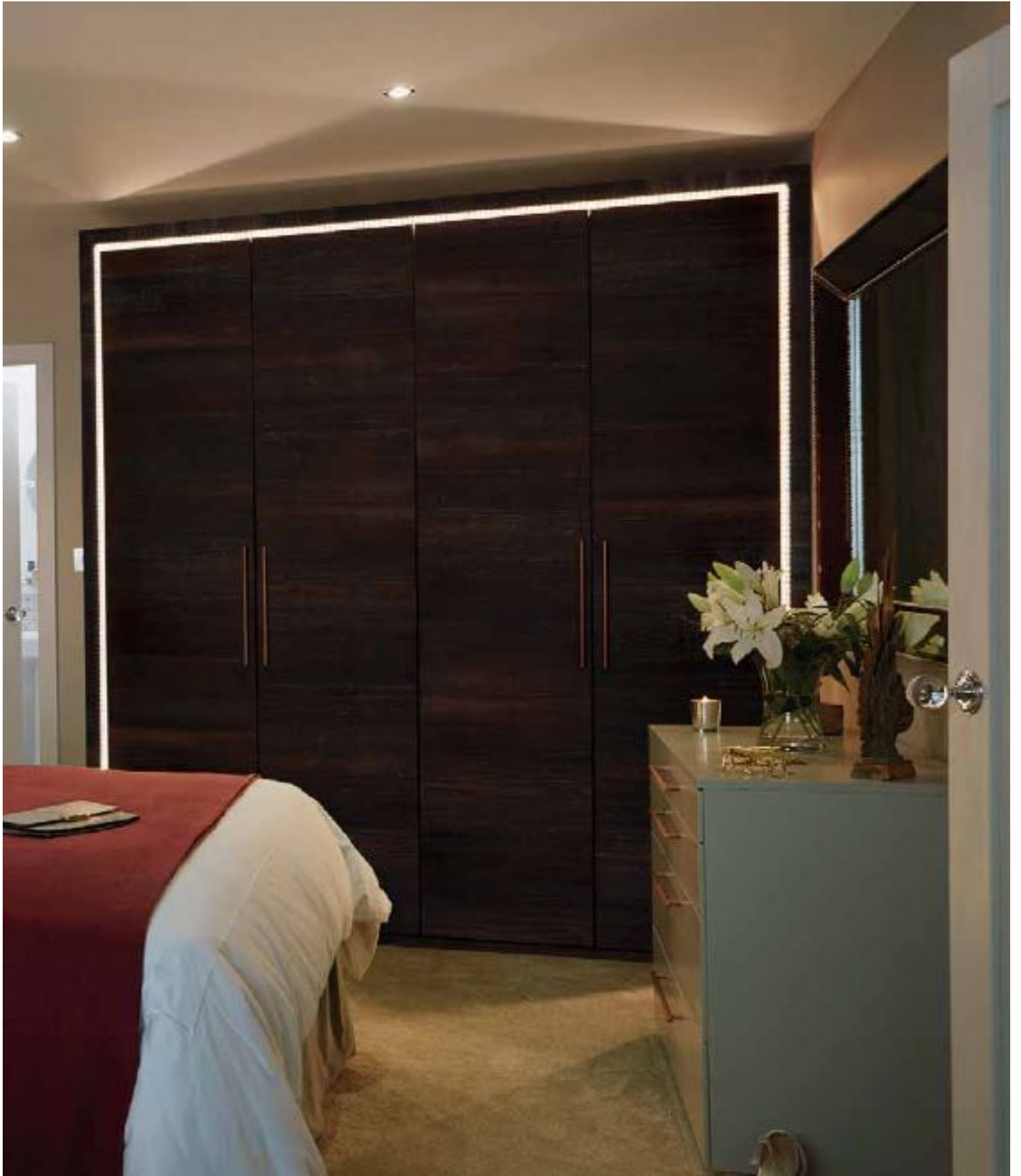

The Made-to-Measure Collection

ALPINA

Inherently natural and beautiful in appearance.

Combining striking real timber veneers with heavily embossed textures
Alpina exudes an air of drama and luxury in any bedroom.



One door style

5 FINISHES AVAILABLE

See Alpina range overview for swatches on page 73

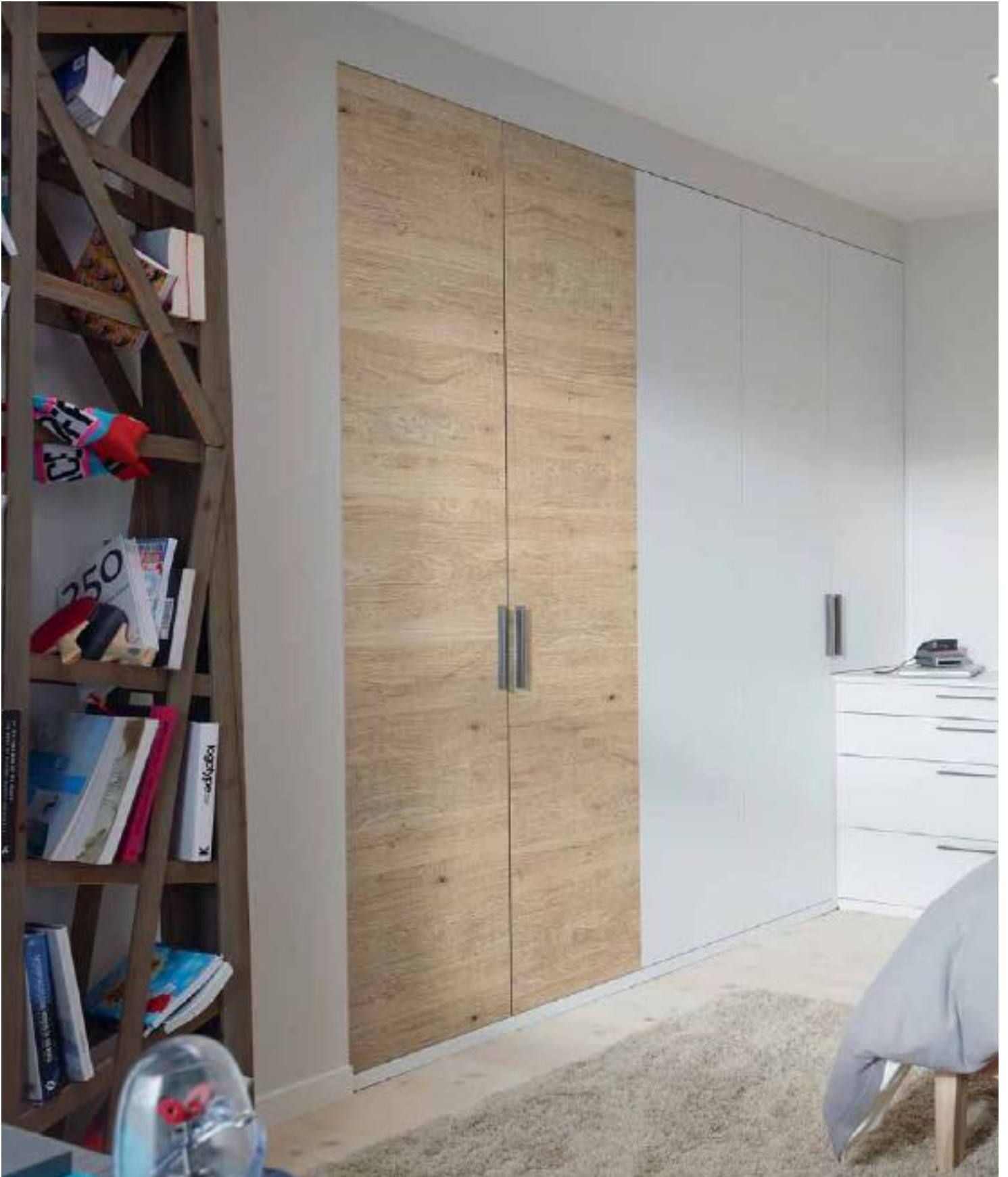

The Made-to-Measure Collection

ALPINA



NATURAL OAK
MATT



SMOKED LARCH
MATT



MID OAK



BURNT ASH



DEEP OAK
MATT

THE MADE-TO-MEASURE COLLECTION
ALPINA RANGE OVERVIEW



The Made-to-Measure Collection

STANHOPE

From the simplicity of Acomb or the versatility of Bolam, through to the elegance of Elsdon, this collection showcases a selection of door designs and bedroom styles, to truly highlight the creativity and flexibility that Made to Measure solutions can offer.

Classic

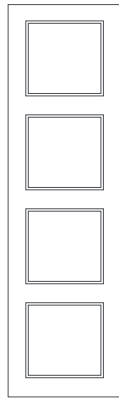

Elsdon

4 panel -
1 piece shaker

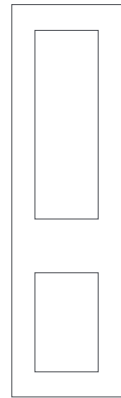

Bolam

1 piece
shaker



Whitfield

Square Slab

Modern

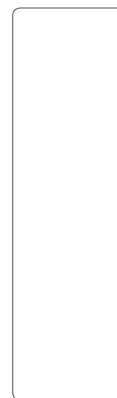

Henshaw

Sapponetta
Slab



Acomb

Integrated
Handle

THE MADE-TO-MEASURE COLLECTION
STANHOPE

OVER 25 FINISHES AVAILABLE

See Stanhope range overview for swatches on page 77

The Made-to-Measure Collection

STANHOPE

CLASSIC



Elsdon

4 panel -
1 piece shaker



Bolam

1 piece
shaker



AVAILABLE IN
ANGLED DOORS

Matt

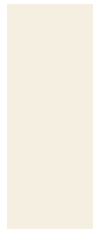

PORCELAIN



STONE



ALABASTER



BLUE
CANVAS



MUSSEL



CASHMERE



DOVE GREY

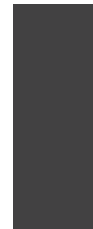

GRAPHITE

Woodgrain



SUPERWHITE



CREAM



GREY



MUSSEL



CASHMERE

MODERN

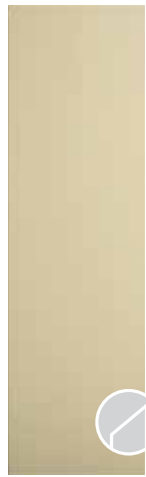

Whitfield
Square Slab



Henshaw
Sapponetta
Slab



Acomb
Integrated
Handle



AVAILABLE IN
ANGLED DOORS

Gloss - *Acomb not available in Gloss*



WHITE



CREAM



HAZE
(WHITE
BACK)



CONCRETE
(LIGHT GREY
BACK)



SUPER
WHITE



CREAM



GREY



MUSSEL



CASHMERE

Feature

Woodgrain

Matt

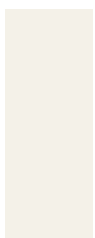

PORCELAIN



STONE



ALABASTER



MUSSEL



CASHMERE



DOVE GREY



BLUE
CANVAS



GRAPHITE



The Made-to-Measure Collection

BOLAM

A modern twist on a staple favourite.

A smooth shaker design with gently rounded edges: Bolam sits comfortably as a softer variation to a classic shaker. From smooth matt colour, to detailed woodgrain effect- Bolam is available in a wide selection of colours and finishes, giving it the ability to adapt to suit its surroundings.

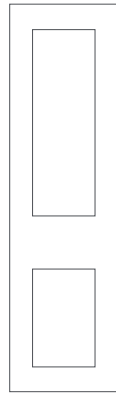

Bolam

Part of the Classic family of Stanhope

Over 10 finishes Available.

See Stanhope made-to-measure range overview for swatches on page 77.



BOLAM

Shown in Grey Woodgrain

1. Angled door detail within the Bolam range
2. Handle detail from the Chrome Collection (BH1092.64.CH)
3. Bespoke bedside chest featuring handle from the chrome collection
4. Wardrobe showing angled back to fit seamlessly within an eave
5. Triple run of integrated chests



GET THE LOOK

A relaxing palette of soft grey and dusty pink adds a feminine charm and an air of comfort to a compact loft bedroom.

Mixing inviting soft furnishings, with glints of chrome and elements of woodgrain encourages the depth of hygge living.





3

BOLAM
SHOWN IN GREY WOODGRAIN



4



5



The Made-to-Measure Collection

ELSDON

Merging contemporary shaker door style
with a decorative moulded detailing.

Elsdon pairs a contemporary shaker door design and a decorative moulded centre panel for a chic, decorative twist. Available in matt colours for a modern edge or a selection of woodgrain effect finishes for a traditional appearance, the Elsdon door adds sophistication and class to any modern or classic setting.

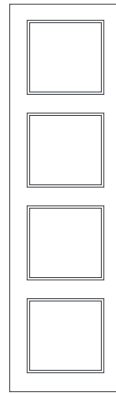

Elsdon

Part of the Classic family of Stanhope

Over 10 finishes Available.

See Stanhope made-to-measure range overview for swatches on page 77



1



GET THE LOOK

Simple Chrome elements sit beautifully against striking Graphite, paired with light blue and soft silver hues for a grand space that oozes contemporary sophistication.

Create a multi-purpose wardrobe design by integrating drawers for a clever storage solution. Awkward wall spaces can be utilised with a 45 degree angled door, softening the end of a run and creating a focal point.



2



ELSDON
SHOWN IN MATT GRAPHITE

ELSDON

Shown in Matt Graphite

1. Showcasing a made to measure chest of drawers with handles from the Chrome Collection (BH1120.160.CH)
2. Handle from the Chrome Collection (BH1120.160.CH)
3. 2 drawer made to measure bedside chest with handles from the Chrome Collection
4. Wardrobe configuration showing a combination wardrobe and a 45 degree angled door





The Made-to-Measure Collection

UNITY

Minimalist and un-complicated in design, Unity offers the most creative flexibility of all our ranges.

The pure, linear design enables you to adapt to any space. Whether it's effortlessly simplistic, or sophisticated and full of character, with over 20 shades spanning lustrous high gloss, ultra-modern super-matt, shimmering metallic, woodgrain effect finishes and even the choice of door edging; the possibilities are endless.



One door style

Over 20 finishes Available.

See range overview for swatches on page 89

Edge options



Matching
AirTech Edge

MATT ONLY



Two-Tone
3D glass effect

(GLOSS DOORS ONLY)

The Made-to-Measure Collection

UNITY

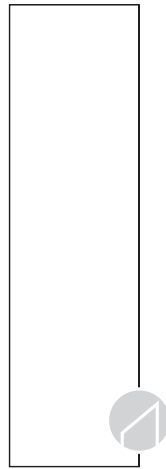

Over 20 finishes Available.



Available in angled doors

Woodgrain Effect (Matching Edge Only)



CHARACTER
GRAPHITE



RECLAIMED
OAK



WHITE
HALIFAX OAK



NATURAL
DAVOS OAK



SEPIA
GLADSTONE
OAK



BLACK



CERAMIC
ANTHRACITE

Gloss Finishes



PURE WHITE



CASHMERE



LIGHT GREY



DUST GREY



LAVA



GRAPHITE

Gloss Metallic Finishes



FJORD METALLIC



GOLD METALLIC

Supermatt Finishes (Matching Edge Only)



PURE WHITE



CASHMERE



LIGHT GREY



DUST GREY



GRAPHITE

Edge Options



MATCHING
AIRTECH EDGE



TWO-TONE
3D GLASS EFFECT
(GLOSS DOORS ONLY)



GET THE LOOK

Fitting seamlessly to the silhouettes of the room these combination wardrobes show the perfect way to utilise eaves effectively to create as much storage space as possible.

The pale shades of grey and white combined with the linear shapes of the doors perfectly suit this minimalist bedroom.





UNITY

Shown in Supermatt Pure White and Supermatt Light Grey

1. Made to measure combination wardrobe
2. Made-to-measure dressing table
3. Made-to-measure bedside with open section



UNITY
SHOWN IN SUPERMATT PURE WHITE AND SUPERMATT LIGHT GREY





GET THE LOOK

Beautifully balanced, peaceful and calm - the neutral shades of Gloss and Supermatt Cashmere with hints of Blush, Metallic Gold and Brass, showcase a perfectly serene setting for relaxing.

The wardrobes cleverly utilise the space above the bed and maximise corner storage without dominating the floorspace, perfectly demonstrating the benefits of a made to measure bedroom.



UNITY

Shown in Gloss and Matt Cashmere with Gloss Gold Metallic features

1. Fitted over bed with a Gloss Gold Metallic headboard detail
2. 4 drawer chest made from Gloss and Matt Cashmere drawer fronts
3. Combination unit with a 4-drawer chest made from Gloss and Matt Cashmere drawer fronts and a Feature Gold Metallic open unit
4. Floating bedside with a handle from the Knurled Collection (BK1111.20B384BR)

PLANNING YOUR BEDROOM

MADE-TO-MEASURE COLLECTION

STEP 1

Measure your space

Ensure you are fully equipped to start planning. Measure your space wall to wall, including ceiling heights. Remember to note down things like:

- ✓ Sockets
- ✓ Switches
- ✓ Window ledges
- ✓ Doors
- ✓ Radiators

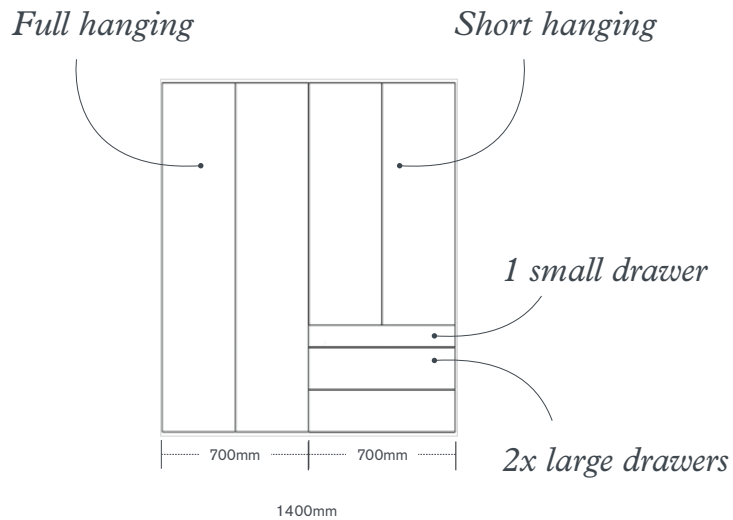
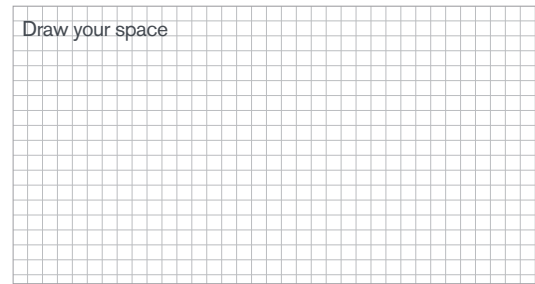

STEP 2

How many doors

Using the measurements get an idea of the wardrobe storage you want by drawing out how many drawers and doors you want

STEP 3

Add end panels/fillers or posts.

Decide if you want to include end panels, fillers or posts on your wardrobes or have a decorative cabinet

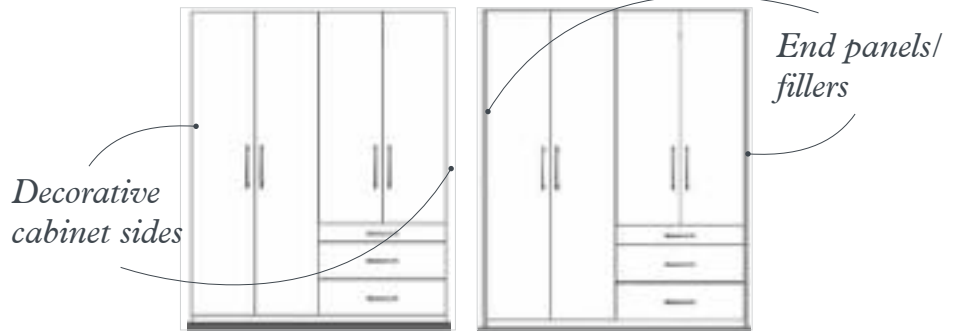

Wardrobes right to the ceiling



Wardrobes with space above



STEP 4

Height

Decide what height you want your storage to be

PLANNING YOUR BEDROOM
MADE-TO-MEASURE COLLECTION

STEP 5

Add your internals

Depending on your storage needs design your own internals.

For the full internals section please see page 119.



THE ITALIAN
KITCHEN COMPANY

THE SLIDING COLLECTION





THE SLIDING COLLECTION

A collage of interior design materials. In the center is a floor plan with labels for 'Bedroom 4', 'Bedroom 2', 'Bedroom 3', 'En-suite', 'Landing', and 'Bathroom'. Surrounding the plan are various fabric swatches in shades of beige, cream, and brown. There are also decorative items like a candle, a glass, and a small clock. The background is a wooden surface.

WHY CHOOSE
SLIDING
WARDROBES

SPACE

We'll help you achieve more than you ever thought possible. Sliding doors can be used to maximise your space and storage by flawlessly fitting into any space. Why not utilise existing recesses or alcoves to create functional storage spaces, offering twice as much storage as a free-standing unit.

QUALITY

Expertly created in the UK we manufacture each wardrobe specifically to your required dimensions and designs. With solid aluminium frames, specifically selected glass panel boards and soft closers fitted as standard not only will these bespoke wardrobes fit your space perfectly, but they will form a timeless setting for years to come.

SOFT CLOSE
as standard

**COLOUR
MATCHED**
dust brushes

UK
manufactured

BESPOKE
*tailored to
any space*

FINISHES
*5 frame types
6 frame colours
7 door styles
Over 30 door colours*

Tailored
**INTERNAL
STORAGE**



THE SLIDING COLLECTION

Our range of sliding doors enable maximum space whether it's a loft of sloping eaves, impressive heights of Georgian ceilings, or a quaint cottage footprint. Truly bespoke in function, we offer an extensive range of glass, satin glass, mirror and panel options to choose from.



FULL PANEL



EQUAL TWO



LOW 400



CENTRAL 400



EQUAL THREE



WIDE 400



WIDE 300

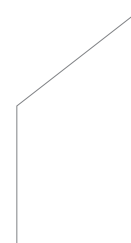

ANGLED DOORS
AVAILABLE

Maximum door height 2500mm

Door width 600mm - 1100mm



Frame shown:
Cube in Satin Silver

*Choose your frame
and finish*

FRAME OPTIONS

Choose from five different frame shapes and six different colour options to tailor your wardrobe to your personal taste.

Pick your desired frame profile and colour.

PRISM

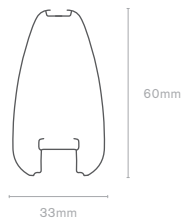
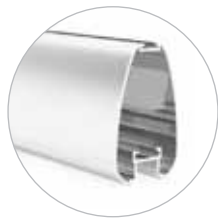

FIGURE

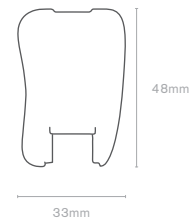
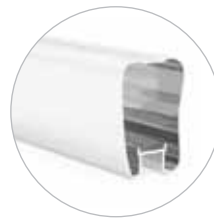

CURVE

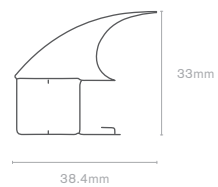

CUBE

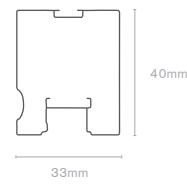
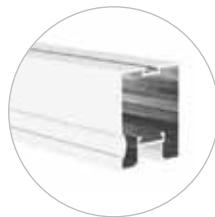

SHAPE

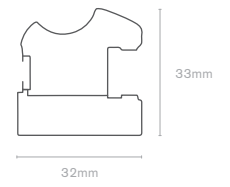
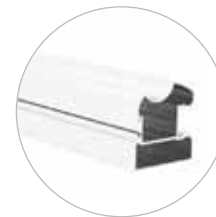

FRAME PROFILE COLOURS



SATIN SILVER



WHITE GLOSS



BLACK GLOSS



CHAMPAGNE



WENGE WOODGRAIN



WENGE HIGH GLOSS



Door colours shown:
Satin Silver Glass and White Glass

DOOR COLOURS

Choose from over 30 door colour options ranging from glass, satin glass, mirror, matt, gloss and textured woodgrain boards.

Pick your chosen door colours for your chosen door style.

Door
thickness
8mm

THE SLIDING COLLECTION
DOOR COLOURS

BOARD COLOURS		WOODGRAIN BOARDS		MIRROR
MATT WHITE	GLOSS WHITE	CLASSIC PORCELAIN	OAK	SILVER MIRROR
MATT CASHMERE	GLOSS CASHMERE	CLASSIC STONE	WALNUT	BRONZE MIRROR
MATT DOVE GREY	GLOSS DOVE GREY	CLASSIC GREY		GREY MIRROR
MATT ANTHRACITE				
GLASS COLOURS		SATIN GLASS COLOURS		
WHITE	CASHMERE	SATIN WHITE	SATIN CASHMERE	
ALUMINIUM	DAKAR	SATIN SILVER	SATIN DAKAR	
ANTHRACITE	STONE GREY	SATIN ANTHRACITE	SATIN STONE GREY	
CLASSIC GREY	METAL TAUPE	SATIN DOVE GREY	SATIN BRONZE	
BLUE SHADOW	AUBERGINE	SATIN BLACK		
STARLIGHT BLACK				



Liners and end panels shown:
Matt White

ACCESSORIES

END PANELS AND LINERS

In a wall to wall wardrobe we always recommend using 4 x liners to create a finished edge for the doors to run into. These also help to disguise imperfections where walls, floors and ceilings are uneven.

End panels are great to use if you don't have a wall to wall space, or to reduce the height left at the top of the wardrobe in instances with high ceilings.



END PANEL

2800mm L x 620mm W x 18mm D



LINER

2800mm L x 100mm W x 18mm D

Pick your end panel or liner colours to suit your chosen door design.

BOARD COLOURS		WOODGRAIN BOARDS		Panel thickness 18mm
MATT WHITE	GLOSS WHITE	CLASSIC PORCELAIN	OAK	Linen is only recommended for internal use
MATT CASHMERE	GLOSS CASHMERE	CLASSIC STONE	WALNUT	
MATT DOVE GREY	GLOSS DOVE GREY	CLASSIC GREY	LINEN	
MATT ANTHRACITE			GREY LINEN	

INTERNALS

SHELF AND HANGING RAIL

The shelf and hanger rail provides a practical standard hanging solution.

Can be used individually or multiples combined together with the use of an end panel between for larger widths; additionally to this you could use end panels to create shelves.



SHELF AND HANGER

Standard storage fits a maximum width of 2500mm and are 620mm deep

Choose the colour you require for your shelf and hanging rail.

BOARD COLOUR	WOODGRAIN BOARDS		TEXTURED	HANGING RAIL
MATT WHITE	CLASSIC PORCELAIN	OAK	BEIGE LINEN	SILVER
MATT CASHMERE	CLASSIC STONE	WALNUT	GREY LINEN	
MATT DOVE GREY	CLASSIC GREY			
MATT ANTHRACITE				

Panel thickness
18mm



Shelf

Hanging rail

Central support

SLIDING COLLECTION BOARD MATCH CHART

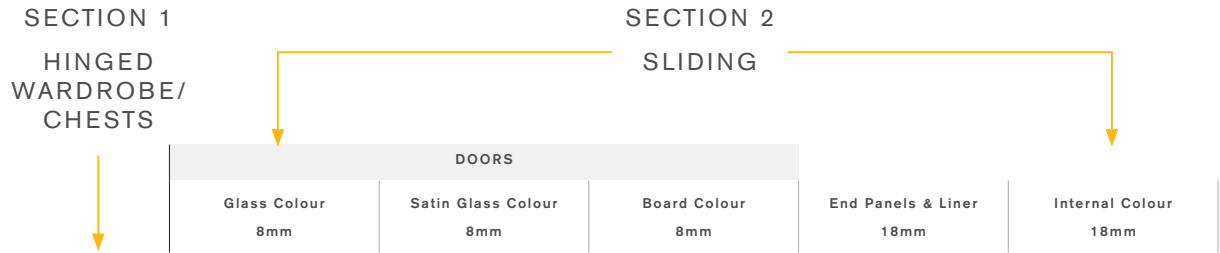

These finishes are relating to the

MODERN COLLECTION:

- Modern Chests
- Sculpt
- Parity
- Flow
- Esker

Modern - Matt	Glass Colour 8mm	Satin Glass Colour 8mm	Board Colour 8mm	End Panels & Liner 18mm	Internal Colour 18mm
White	WHITE	SATIN WHITE	MATT WHITE	MATT WHITE	MATT WHITE
Cashmere	CASHMERE	SATIN CASHMERE	MATT CASHMERE	MATT CASHMERE	MATT CASHMERE
Dove Grey	N/A	N/A	MATT DOVE GREY	MATT DOVE GREY	MATT DOVE GREY
Anthracite	ANTHRACITE	SATIN ANTHRACITE	MATT ANTHRACITE	MATT ANTHRACITE	MATT ANTHRACITE

Modern - Gloss	Glass Colour 8mm	Satin Glass Colour 8mm	Board Colour 8mm	End Panels & Liner 18mm	Internal Colour 18mm
White	WHITE	SATIN WHITE	GLOSS WHITE	GLOSS WHITE	N/A
Cashmere	CASHMERE	SATIN CASHMERE	GLOSS CASHMERE	GLOSS CASHMERE	N/A
Dove Grey	N/A	N/A	GLOSS DOVE GREY	GLOSS DOVE GREY	N/A

These finishes are relating to the

CLASSIC COLLECTION:

- Classic Chests
- Chapter
- Origin

Classic	Glass Colour 8mm	Satin Glass Colour 8mm	Board Colour 8mm	End Panels & Liner 18mm	Internal Colour 18mm
Porcelain	N/A	N/A	CLASSIC PORCELAIN	CLASSIC PORCELAIN	N/A
Partridge Grey	CLASSIC GREY	N/A	CLASSIC GREY	CLASSIC GREY	N/A
Stone	CASHMERE	SATIN CASHMERE	CLASSIC STONE	CLASSIC STONE	N/A

TO MATCH;

Wardrobe/Chest finishes with sliding finishes.

Use both sections. Use the left column to choose your finish. View horizontally to see which Sliding door finishes, end panels/liners and internal colours are the best match for your chest finish.

TO MATCH;

Sliding door finishes with end panels and internals.

Only use Section 2 - Sliding. View horizontally to see what recommendations we have to the closest match when choosing your sliding doors and accessories finishes.

CREATE THE LOOK

DOOR STYLE

Equal three and full panel

DOOR FINISH

Satin Anthracite Glass
and Silver Mirror

ACCESSORIES

Matt Anthracite

FRAME PROFILE

Shape in Satin Silver



CHEST

Modern, 4 drawer chest

COLOUR

Matt Anthracite

HANDLE

From the Chrome collection

DOOR STYLE

Full panel

DOOR FINISH

Stone Grey Glass*

ACCESSORIES

Matt Cashmere*

FRAME PROFILE

Curve in Black Gloss



CHEST

Modern, 4 drawer chest

COLOUR

Matt Cashmere

HANDLE

From the Timber collection

*Close match, but not exact

PLANNING YOUR BEDROOM

SLIDING COLLECTION

STEP 1

Pick your desired frame profile and colour.

ALUMINIUM FRAME PROFILES



PRISM



FIGURE



CURVE



CUBE



SHAPE

FRAME PROFILE COLOUR

SATIN SILVER



WHITE GLOSS



BLACK GLOSS



CHAMPAGNE



WENGE WOODGRAIN



WENGE HIGH GLOSS



STEP 2

Pick your desired door design.

Maximum door height 2500mm

Door width 600mm -1100mm

DOOR RANGE

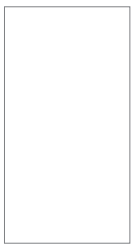

FULL PANEL



EQUAL TWO



LOW 400



CENTRAL 400



EQUAL THREE



WIDE 400



WIDE 300

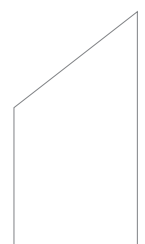

ANGLED DOORS
AVAILABLE

STEP 3

Pick your chosen door colours for your chosen door style.

DOOR COLOURS

Door
thickness
8mm

BOARD COLOURS		WOODGRAIN BOARDS		MIRROR
MATT WHITE	GLOSS WHITE	CLASSIC PORCELAIN	OAK	SILVER MIRROR
MATT CASHMERE	GLOSS CASHMERE	CLASSIC STONE	WALNUT	BRONZE MIRROR
MATT DOVE GREY	GLOSS DOVE GREY	CLASSIC GREY		GREY MIRROR
MATT ANTHRACITE				

GLASS COLOURS		SATIN GLASS COLOURS	
WHITE	CASHMERE	SATIN WHITE	SATIN CASHMERE
ALUMINIUM	DAKAR	SATIN SILVER	SATIN DAKAR
ANTHRACITE	STONE GREY	SATIN ANTHRACITE	SATIN STONE GREY
CLASSIC GREY	METAL TAUPE	SATIN GREY	SATIN BRONZE
BLUE SHADOW	AUBERGINE	SATIN BLACK	
STARLIGHT BLACK			

STEP 4

Pick your end panel or liner colours to suit your chosen door design.

END PANELS AND LINERS

Panel thickness 18mm

BOARD COLOURS		WOODGRAIN BOARDS	
MATT WHITE	GLOSS WHITE	CLASSIC PORCELAIN	OAK
MATT CASHMERE	GLOSS CASHMERE	CLASSIC STONE	WALNUT
MATT DOVE GREY	GLOSS DOVE GREY	CLASSIC GREY	BEIGE LINEN
MATT ANTHRACITE			GREY LINEN

Linen is only recommended for internal use

STEP 5

Choose the colour you require for your shelf and hanging rail.

SHELF AND HANGING RAIL

BOARD COLOURS	WOODGRAIN BOARDS	TEXTURED	HANGING RAIL
MATT WHITE	CLASSIC PORCELAIN	BEIGE LINEN	SILVER
MATT CASHMERE	CLASSIC STONE	GREY LINEN	
MATT DOVE GREY	CLASSIC GREY		
MATT ANTHRACITE	OAK		
	WALNUT		

Panel thickness 18mm

For additional internal storage options, please speak with a Kindred sales person.



Liner

Liner

Top track

End Panel

Doors

Rail Profile

Mid Rail -

used between each section of board, mirror or glass

Runners/wheels

Liner

Bottom track

A dark wood wardrobe with a large mirror and a framed picture. The mirror is illuminated from above, and the wardrobe has a vertical wood grain pattern. The text "THE FINISHING TOUCHES" is overlaid in white, bold, sans-serif font.

THE
FINISHING
TOUCHES



Creating the perfect bedroom doesn't stop with choosing a particular range. Our collection offers various ways to customise your bedroom and add personality to any style.

From handles, lighting and an array of internal options, the opportunities to personalise are endless.

FINISHING TOUCHES



INTERNAL STORAGE

To create the perfect wardrobe, planning starts from within. Clever, flexible and beautiful in design, our wardrobe internals have been carefully considered to work around your needs.

Available in Walnut, Oak and Linen finishes, choose from stackable drawers, accent shelves, drawer organisers, shoe storage and pigeon units.

Alternatively make a bespoke internal solution, tailored to your personal needs.

View our full internal storage options at [kindred.co.uk](https://www.kindred.co.uk) or find more information on the following pages.



ADDITIONAL SHELVES



ADDITIONAL HANGING RAILS

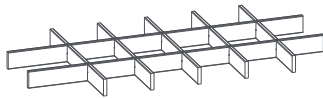

DRAWER ORGANISER

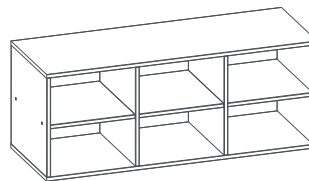

PIGEON HOLE UNIT

Internal colours available



LINEN



OAK



WALNUT

Some items are available in limited colour ways

SHELVES AND HANGING RAILS

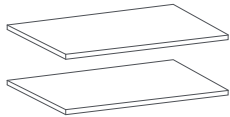

ADDITIONAL SHELVES

Don't sacrifice beauty on the inside if you don't need too. Our range of internal shelving allows you to customise your new wardrobe to cater for your every need. Shelves are sold in pairs and designed to fit inside all wardrobe widths.



ADDITIONAL HANGING RAILS

Designed to work well in all our wardrobes, the premium Satin Brown Hanging Rail perfectly complements the textured linen cabinet, providing additional storage space.

COLOURS AVAILABLE



PIGEON HOLES

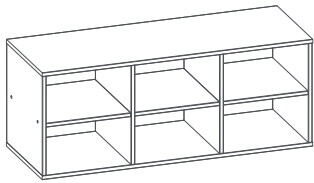

PIGEON HOLE UNIT

Designed only to suit the 1000mm width wardrobe, the Pigeon Hole Unit creates practical yet premium storage compartments that can be used for perfume bottles, handbags, shoes or folded clothing items, for an easy to reach storage solution.

COLOURS AVAILABLE



LINEN



OAK



WALNUT



INTERNAL STORAGE
STACK. STORE. DISPLAY.

STACKABLE DRAWERS

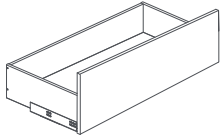

SHALLOW

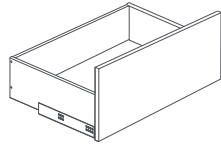

DEEP

Available in both shallow and deep drawer heights, as well as all three frontal colours, these individual drawers can maximise storage; whether used singly or in multiples.

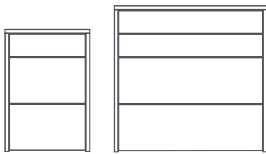

In order to make it easier for you to fulfil your storage needs, we have combined individual stackable drawers to create bundles. Choose from 3 and 4 drawer bundles, in widths to fit 500, 800, 900 and 1000mm wardrobes.

COLOURS AVAILABLE



LINEN



OAK



WALNUT





INTERNAL STORAGE
STACK. STORE. DISPLAY.

SHOE STORAGE



LINEN ONLY



SHOE RACK CONVERSION KIT

This simple element perfectly matches with the textured Linen cabinet. Available in one size, it can be cut down to suit any of our wardrobes, to allow it to be used either on the bottom of a wardrobe or placed on shelves with ease.

COMBINED WITH DRAWERS



SHOE RACK CONVERSION KIT

+

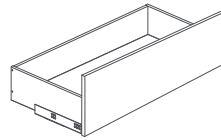

SHALLOW

In our opinion, there's no such thing as too many pairs of shoes! That's why we've created additional storage, combining the shoe rack conversion with shallow height stackable drawers, to ensure easy access and a flawless solution to storage.





INTERNAL STORAGE
STACK. STORE. DISPLAY.

DRAWER ORGANISER

LINEN ONLY

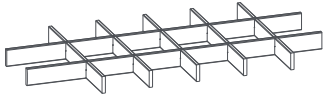

DRAWER ORGANISER

Designed to work perfectly within the 1000mm shallow stackable drawer, this Linen organiser can help to store even your smallest possessions.

(Can also be cut down to use in smaller widths)



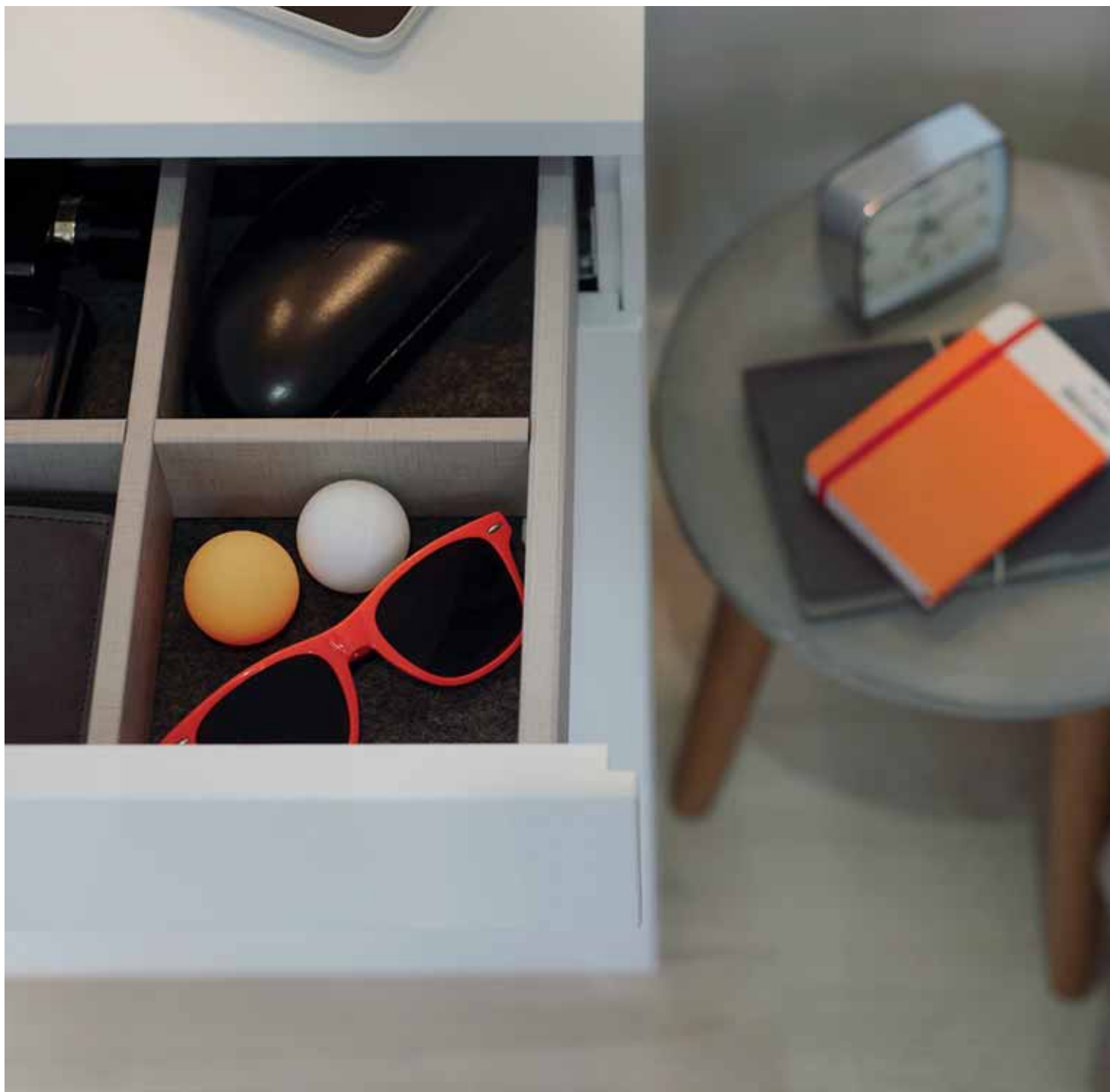

INTERNAL STORAGE
STACK. STORE. DISPLAY.

FELT LINER

The perfect finishing touch, the Felt Drawer Liner is available pre-cut to fit the 1000m stackable drawer, or a 4 drawer modern chest. Offering a non-slip solution, the soft grey felt liner can also be cut to fit a smaller storage space, to suit bedside tables and smaller stackable drawers.



FELT LINER

BUNDLES

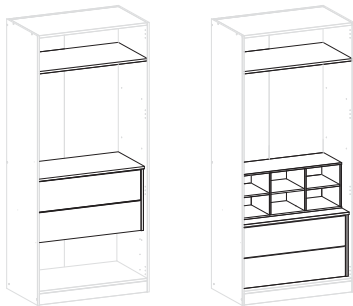

For those struggling to decide on which internals to choose, we can take away the pressure with a predetermined wardrobe bundle. With over 10 combinations for 500, 800 and 900mm wardrobes, and 16 options for 1000m wardrobes, you're bound to find the selection that's perfect for your storage requirements.

COLOURS AVAILABLE



LINEN



OAK



WALNUT

*Wardrobes are sold separately



EVOLINE

BACKFLIP

The Evoline BackFlip sits nearly flush on a surface. At a touch of a finger, it turns 180 degrees to reveal two power sockets and a USB charger. With a total installation height of just 53mm, the BackFlip can be fitted above most drawers. Perfect to use on custom desks.

BLACK GLASS (GLOSS)



STAINLESS STEEL



WHITE GLASS (GLOSS)



*European socket is shown for display purposes only.
This product will come with a UK socket.



INTERNAL STORAGE
STACK. STORE. DISPLAY.

LIGHTING

SPOT LIGHTS

The LED chrome spotlights, SLS Quadra and Magnum lights create a subtle internal ambience when in use.

PINTO
LED Flat Disc Light



SLS QUADRA MODERN
LED Under/Over Cabinet Light



MAGNUM
Rechargeable Battery Light
No wiring required



SENSORS

250W MOTION SENSOR SWITCH



This can be mounted inside a cabinet unit and will detect once the door is opened and will switch the light fitting on.

CABINET SENSOR SWITCH



Recess into the front of an interior shelf inside the cabinet. On opening the door the connected internal lights will switch on, when the door is closed the lights will switch off.

PLINTH LIGHTS

Integrate plinth lighting into your bedroom design to add dimension and depth. Our plinth lighting collection is stylish and discreet to create a stunning effect.

SPECTO LED Round Plinth Light



LUCE SLS LED Square Plinth Light



STRIP LIGHTING

The LED strip is our most versatile lighting option. This plug and play lighting can be used to back-light shelves, frame wardrobes or highlight dressing areas.

PRIMO 5M Clip LED Flexible Strip



MAKE A FEATURE

MODERN

Within our Modern Collection you can design your very own unique space, with our beautiful range of feature doors. Create a focal point with the rich tones of Walnut or make a statement with our glass and mirror doors.



MIRROR
GREY
TINTED



GLASS
BRONZE
TINTED



WALNUT

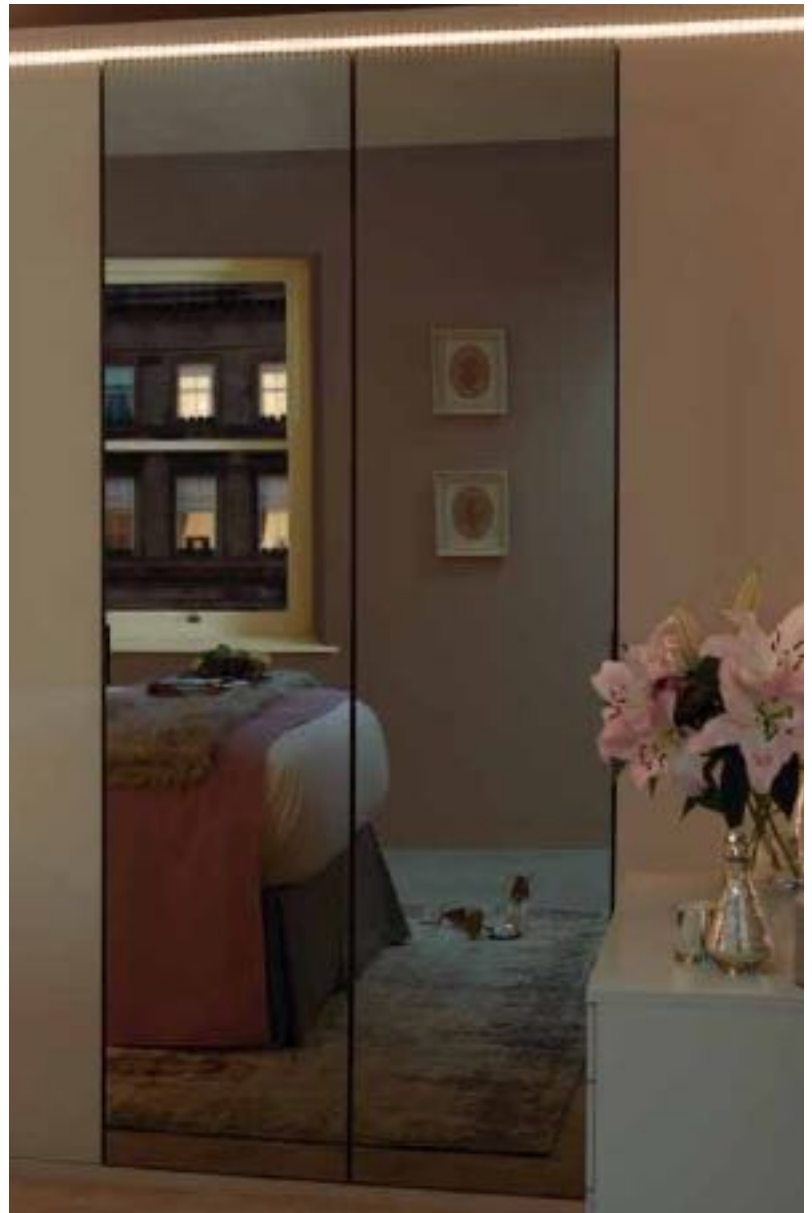



CLASSIC

Within our Classic Collection, tailor your space with the matching mirrored doors.

Textured woodgrain finishes



PORCELAIN



PARTRIDGE
GREY



STONE



OAK
EFFECT



MAKE A FEATURE
MIRROR - GLASS - WALNUT

THE HANDLE COLLECTION



Our collection also offers an extensive choice of handles to enhance both classic and modern styles. It's the finer detail in the handle that can pull your room together, that's why its important for us to offer you variety as part of your bedroom design.

For any Kindred customers looking to update existing wardrobes or furniture, our handles can allow you to add your personal style.

Choose from over 150 handles.

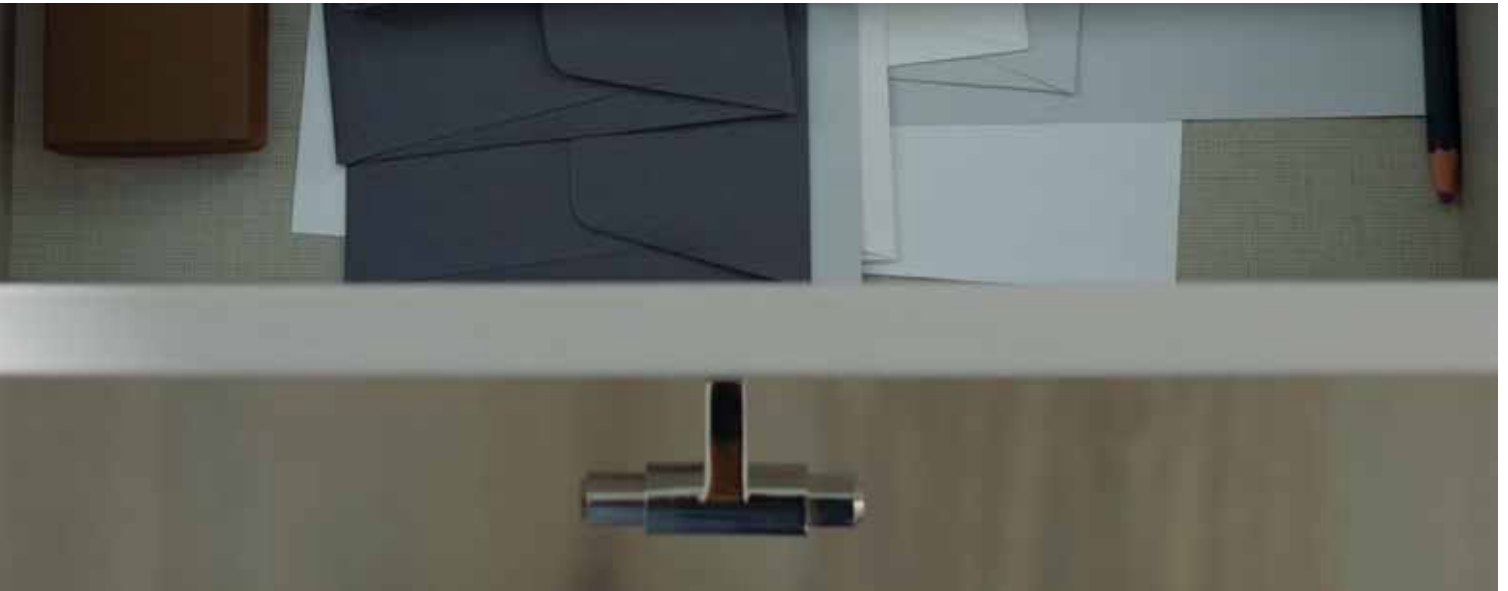

STAINLESS STEEL EFFECT



Arlington
Bar Handle
1 BH503.128.SS



Dartmouth
Bar Handle
4 BH1128.160.SS



Portland
Cup Handle
1 B1003/79SS



Arlington
T-Bar Handle
1 BH503.60.SS



Dartmouth
T-Bar Handle
2 BH1123.60.SS



Portland
Knob Handle
1 BTK2SS



Block Handle
2 KDH3000
2 KDH3001



Clerkenwell
Trim Handle
2 BH1124.96.SS
2 BH1124.256.SS



Crystal Knob
Stainless Steel and
Crystal effect
2 KDH3014



Teardrop Trim Handle
1 BH1087.32.SS
1 BH1087.160.SS



Guildford
Cup Handle
1 BH1027.32.SS
2 BH1028.64.SS
2 BH1029.128.SS

HANDLES
STAINLESS STEEL EFFECT AND NICKEL

NICKEL



Bedford
Bar Handle
5 BH882.160.BN



Chelsea
D Handle
2 BH420.128.DN



Bar Handle
2 KDH3010



Bedford
T-Bar Handle
5 BH884.72.BN



Chelsea
Knob Handle
1 BK419.32.DN



T-Bar Handle
1 KDH3011



Belgrave
Satin Nickel Knob Handle
1 BK1107.35.SN



Cup Handle
Antique Nickel
1 B8/952.B.AN

PRICE BANDS

1 2 3 4 5



CHROME



Mayfair
Cup Handle
1 BH1092.64.CH



Chatsworth
Cup Handle
5 BH1127.76.CH



Kensington
D Handle
2 BH768.128.CH



Mayfair
T-Bar Handle
1 BH1091.60.CH



Chatsworth
Knob Handle
4 BK877.35.CH



Kensington
D Handle
4 BH1044.128.CH



Wellington
Round Knob Handle
with backplate
5 BK1075.32.CH



Bloomfield
Bar Handle
3 BH994.160.CH



Kensington
Square Handle
4 BK1043.32.CH



Hoxton
Cup Handle
1 BH1108.96.CH



Bloomfield
Hexagonal T-Bar Handle
2 BH995.68.CH



Flat Handle
1 KDH3030



Hoxton
D Handle
2 BH1085.160.CH



Bar Handle
2 BH1120.160.CH
3 BH1120.256.CH



Square Knob Handle
with backplate
2 KDH3017



Bow Handle
Chrome and Crystal effect
1 KDH3008



T-Bar Handle
2 BH1120.60.CH



Round Knob Handle
with backplate
4 KDH3016



D Handle
Chrome and Crystal effect
3 KDH3013
3 KDH3012



D Handle
2 KDH3027
2 KDH3028



Knob Handle
1 KDH3018



Small D Handle
Chrome and Crystal effect
2 KDH3009



D Handle
2 KDH3029

HANDLES
CHROME

PRICE BANDS

1 2 3 4 5



KNURLED

Stainless Steel



Knob Handle
1 BK1111.20.SS



Knob Handle with backplate
2 BK1111.20B384SS



T-Bar Handle
2 BH1125.35.SS



T-Bar Handle with backplate
3 BH1125.35B385SS



Bar Handle
3 BH1126.257.SS



Bar Pull Handle with backplate
4 B1126.257B385SS



Bar Handle
4 BH1126.448.SS



Bar Handle with backplate
5 B1126.448B385SS

Antique Bronze



Knob Handle
1 BK1111.20.BR



Knob Handle with backplate
2 BK1111.20B384BR



T-Bar Handle
2 BH1125.35.BR



T-Bar Handle with backplate
3 BH1125.35B385BR



Bar Handle
4 BH1126.257.BR



Bar Pull Handle with backplate
4 B1126.257B385BR



Bar Handle
5 BH1126.448.BR



Bar Handle with backplate
5 B1126.448B385BR

Matt Black



Knob Handle
1 BK1111.20.MB



Knob Handle with backplate
2 BK1111.20B384MB



T-Bar Handle
2 BH1125.35.MB



T-Bar Handle with backplate
3 BH1125.35B385MB



Bar Handle
3 BH1126.257.MB



Bar Pull Handle with backplate
4 B1126.257B385MB



Bar Handle
4 BH1126.448.MB



Bar Handle with backplate
5 B1126.448B385MB

HANDLES
KNURLED

PRICE BANDS

1 2 3 4 5

BLACK



Claremont
D Handle
Industrial Matt Black
2 BH1103.160.MB



Bromley
D Handle
Industrial Matt Black
2 BH1129.225.MB



Hoxton
D Handle
Industrial Matt Black
2 KDH3046



Claremont
Cup Handle
Industrial Matt Black
1 BH1105.64.MB



Bromley
Square Knob Handle
Industrial Matt Black
1 BK1112.35.MB



Hoxton
Cup Handle
Industrial Matt Black
2 KDH3045



Claremont
Knob Handle
Industrial Matt Black
1 KDH3044



Barton
Cup Handle
Satin Black
1 BH1092.64.BS



Square Knob Handle
with backplate
Satin Black
2 KDH3040



Trim Handle
Satin Black
1 BH1087.32.BS
1 BH1087.160.BS
1 BH1087.256.BS



Barton
Knob Handle
Satin Black
1 BK1110.33.BS



Round Knob Handle
with backplate
Satin Black
2 KDH3015



D Handle
Matt Black
2 BH1130.160.MB
2 BH1130.320.MB



Knurled D Handle
Matt Black
2 BH1140.192.MB



Geometric D Handle
Satin Black
2 KDH3004
3 KDH3005



Hexagonal Bar Handle
Satin Black
2 KDH3019



Hexagonal T-Bar Handle
Satin Black
1 KDH3020



Cup Handle
Matt Black
BH1138.160.MB



PEWTER



Berwick
Bar Handle
3 KDH3024



Hampshire
Bow Handle
3 KDH3026



Cromwell
Cup Handle
3 BH1111.64.PE



Berwick
Knob Handle
2 KDH3022



Hampshire
Knob Handle
2 KDH3025



Cromwell
Knob Handle
3 BK1109.35.PE



Berwick
Knob Handle with
backplate
2 KDH3023



Knob Handle
1 KDH3042

BROWN AND COPPER



Block Handle
1 KDH3002
1 KDH3003



Bar Handle
1 KDH3006
2 KDH3007



Push Latch
1 KDH3039

PRICE BANDS

1 2 3 4 5



ANTIQUe BRONZE



Claremont
D Handle
2 BH1103.160.BR



Dartmouth
D Handle
4 BH1128.160.BR



Knurled Handle
3 BH1140.192.BR



Claremont
Cup Handle
1 KDH3043



Dartmouth
T-Bar Handle
2 BH1123.60.BR



Bar Handle
1 KDH3047



Claremont
Knob Handle
1 BK1106.30.BR



Collingwood
Knob Handle
5 BK1075.32.BR



Knob Handle
1 KDH3041

BRASS HANDLES



Greenwich
Cup Trim Handle
Aged Brushed Brass
1 BH1138.64.AGB
2 BH1138.160.AGB
3 BH1138.320.AGB



Hampstead
Bar handle
Aged Brushed Brass
1 BH1137.160.AGB
BH1137.224.AGB



Upton
Bar handle
Brushed Brass
2 BH1133.160.BHB
BH1133.320.BHB



Farringdon
Knob Handle
Antique Brass
1 BK266.33.AB



MATT WHITE



Slimline D Handle
2 BH1130.160.MW
2 BH1130.320.MW



Slimline Bar handle
1 BH1137.160.MW
2 BH1137.224.MW



Slimline D handle
2 BH1139.160.MW
2 BH1139.320.MW



Cup Trim Handle
1 BH1138.64.MW
1 BH1138.160.MW
3 BH1138.320.MW



Slimline Bar handle
2 BH1131.90.MW
2 BH1131.250.MW

TIMBER



White
 Solid Wood Handle
 350mm – **2** KDH3037
 800mm – **3** KDH3038



Dove Grey
 Solid Wood Handle
 350mm – **2** KDH3033
 800mm – **3** KDH3034



Cashmere
 Solid Wood Handle
 350mm – **2** KDH3031
 800mm – **3** KDH3032



Anthracite
 Solid Wood Handle
 350mm – **2** KDH3035
 800mm – **3** KDH3036



Knob Handle
1 KDH3021

HANDLES
 ANTIQUE BRONZE, WHITE AND TIMBER

PRICE BANDS

1 2 3 4 5

